

RevNo	Revision note	Date	Signature	Checked

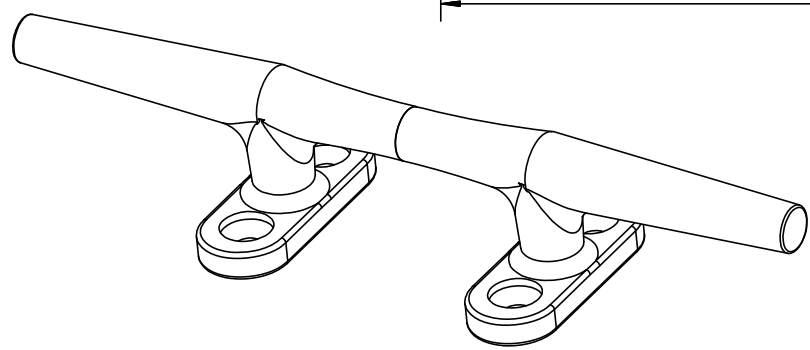
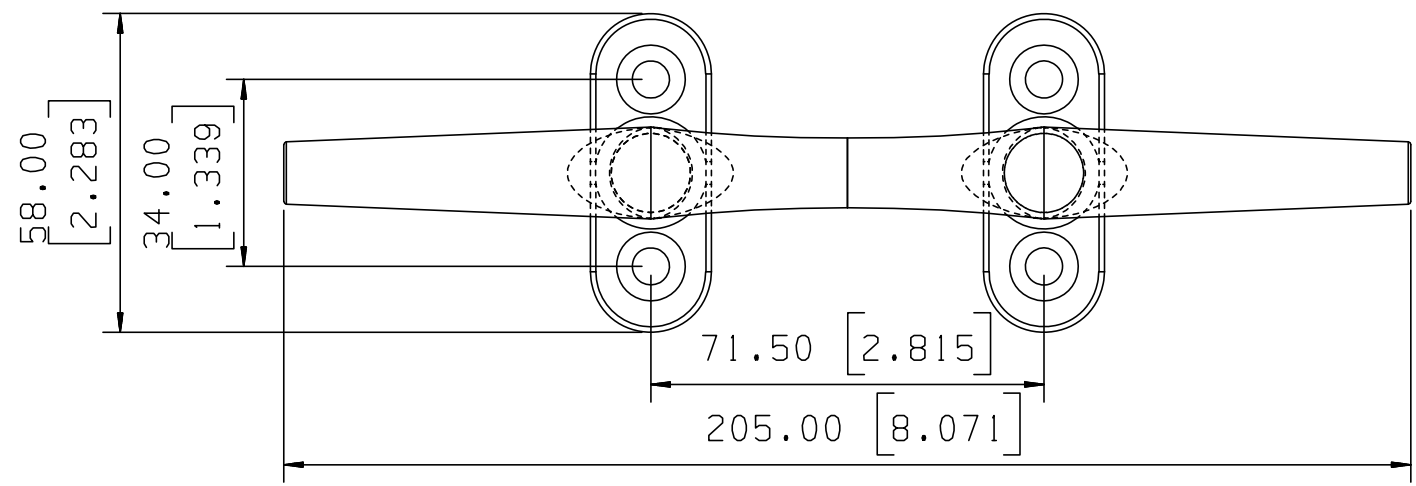
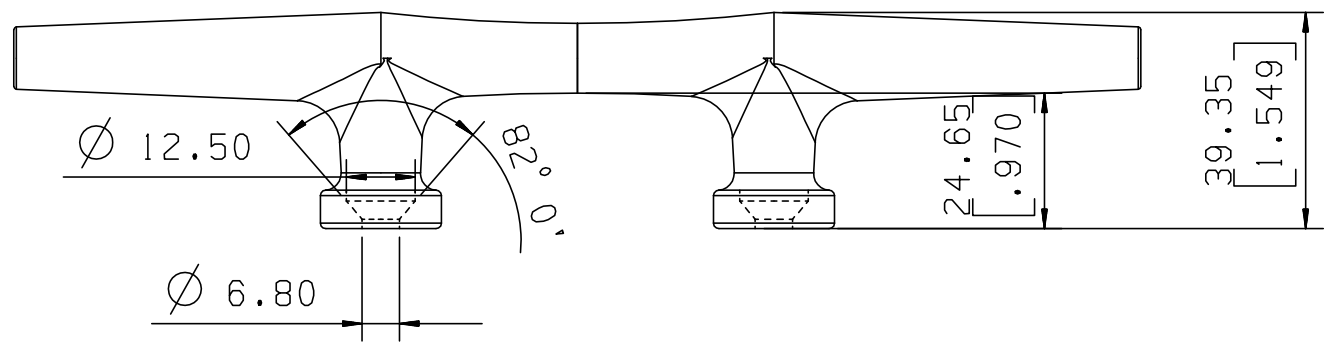

FILE NAME	Z:\Hardware\cleat						
Designed by	Checked by	View	Unit		Material	Date	Scale
MWK	NFM	3th ANGLE	mm		SS 316	2007.03.18	
6032S 8'' CLEAT				CL - 6032S	Edition	RB	Sheet 1 of 1
NEW FOUND METALS CO., LTD.							